









Index
Inhaltsverzeichnis
Оглавление
Spis treści
Indice

GRINTA

	F-MHD' AP	 p. 204
	MHD' AP	p. 204
	F-MHD' RD	p. 205
	MHD' RD	p. 205
	MHD' SE	p. 206
	F-MHD' SP	p. 207
	F-MHD' RA	p. 207





F-MHD' 16 - 20 - 25 - 32



GRINTA is a new D'Andrea solution for milling operations. The program comprises a series of milling cutter bodies that utilize classical milling cutter geometry styles and ISO inserts, thereby increasing the working range of the MHD' Modular System. The MHD' Modular System, already known worldwide for its roughing and finishing boring tools, now makes available to the milling operation its large-capacity and its inherent perfect concentricity and extreme resistance to torsion. At the heart of the system is the coupling: for diameters from 16mm to 32mm the **GRINTA** system takes advantage of dual couplings, that is, the milling heads have a threaded end along with a ground guide accompanied by the modular MHD' connection. For cutter diameters 40mm, 50mm and 63mm, the cutter bodies incorporate the modular MHD' connection.

GRINTA ist eine neue D'Andrea Lösung für Fräsbearbeitungen. Das Programm beinhaltet eine Fräser Linie, welche die klassische Fräsergeometrie und ISO Wendeschneidplatten verwendet, dadurch vergrößert sich der Einsatzbereich des modularen MHD' Systems. Das modulare MHD' System, weltweit bekannt durch seine Schrupp- und Feinstbohrköpfe, stellt jetzt für Fräsbearbeitungen sein großes Leistungsvermögen, dem dazugehörigen perfekten Rundlauf und die extreme Verdrehfestigkeit zur Verfügung. Das Herz des Systems ist die Kupplung: Für die Durchmesser 16mm bis 32mm verwendet das **GRINTA** System den Vorteil einer Doppel-Kupplung, die Fräsköpfe werden durch den geschliffenen MHD' Anschluß geführt und haben am Ende ein Einschraubgewinde. Bei den Fräsdurchmessern 40mm, 50mm und 63mm werden die Fräskörper über den modularen MHD' Anschluß verbunden.

GRINTA - новое решение компании D'Andrea для операций фрезерования. Программа включает серию корпусов фрез, с которыми используются пластины классической геометрии, а также пластины, кодифицированные по ISO, тем самым, расширяя возможности модульной системы MHD'. Модульная система MHD', известная во всём мире, благодаря своим инструментам для чернового и прецизионного растачивания, теперь может использоваться и для операций фрезерования, сохраняя и для них свои основные преимущества высокой соосности, жесткости системы и передаваемого крутящего момента. Основой системы все также является соединение: для диаметров от 16 до 32 мм преимуществом **GRINTA** является двойное соединение фрезы, то есть торцовое резьбовое соединение, дополненное шлифованной направляющей с модульным соединением MHD'. Для фрез диаметрами 40, 50 и 63 мм корпуса имеют модульное соединение MHD'.

GRINTA jest nowym rozwiązaniem firmy D'Andrea, przeznaczonym przede wszystkim do frezowania. Kompletny program składa się z serii korpusów bazowych i końcówek frezarskich, które wykorzystują klasyczne geometrie skrawania i płytki zgodne z normą ISO. Wzrasta w ten sposób możliwość obróbek systemem MHD' za pomocą wytaczaków do obróbki zgrubnej i wykończeniowej, znanych już na całym świecie. Wszystko to po to, aby wykorzystać także w operacji frezowania olbrzymie możliwości systemu modułowego MHD', odnoszące się zwłaszcza do jego doskonałej współosiowości, ale i olbrzymiej odporności na obciążenia skręcające. Sercem systemu jest złącze. Dla połączeń od Ø 16 mm do 32 mm system **GRINTA** wykorzystuje podwójne połączenie. Obciążenia poosiowe przenoszone są przez połączenie gwintowe, a szlifowane elementy gniazda MHD' służą do zapewnienia doskonałej współosiowości. Natomiast dla średnic większych niż 40 mm (także 50 mm i 63 mm) końcówki frezarskie są wykonane z kompletnym połączeniem modułowym MHD'.

GRINTA è la nuova soluzione D'Andrea per la fresatura. Il programma è composto da una serie di corpi fresa che utilizzano le classiche geometrie di taglio ed inserti ISO. Cresce così la possibilità di lavorazioni con il sistema MHD' degli utensili di barenatura a sgrassare e finire, già noti in tutto il mondo e ciò per rendere disponibili anche in fresatura le grandi capacità del sistema modulare MHD' inerenti sia alla perfetta concentricità del sistema MHD' che alla estrema resistenza alla torsione. Cuore del sistema è l'attacco: per i Ø da 16 mm a Ø 32 mm, il sistema **GRINTA** sfrutta il doppio attacco, ovvero testine di fresatura filettate con perno di guida rettificato e cono di accoppiamento MHD' modulare, mentre per i diametri maggiori da 40 mm, 50 mm e 63 mm i corpi fresa sono realizzati con l'attacco diretto modulare MHD'.



MHD' 40 - 50 - 63



F-MHD' AP

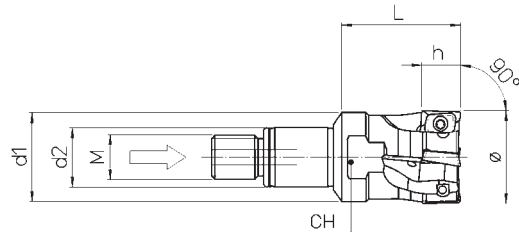

REF.	CODE	Ø	M	d ₁	d ₂	L	h	z	CH			
F-MHD16 AP10-Z2	7516AP10Z220	16	M8	15	10	20	10	2	13	APKT 1003	DG12255	TORX T08
F-MHD20 AP10-Z3	7520AP10Z325	20	M10	19	13	25		3	16			
F-MHD25 AP10-Z4	7525AP10Z432	25	M12	24	16	32		4	21			
F-MHD32 AP10-Z5	7532AP10Z540	32	M16	31	20	40		5	27			

MHD' AP

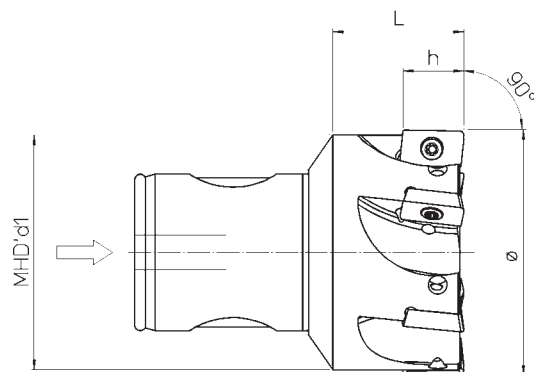

REF.	CODE	Ø	MHD'd ₁	L	h	z			
MHD'40 AP16-Z4	7540AP16Z435	42	40	35	17	4	APKT 1604	DGC04011	TORX T15
MHD'50 AP16-Z5	7550AP16Z535	52	50			5			
MHD'63 AP16-Z6	7563AP16Z635	66	63			6			

p. 262

p. 222

p. 242

p. 75-78

p. 61-72

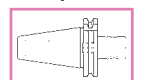
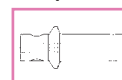

Milling cutters with
round inserts

 Fraeser mit
runden platten

 Фрезы с круглыми
пластинами

 Frezy toroidalne
na płytce okrągłej

 Frese con inserti
tondi

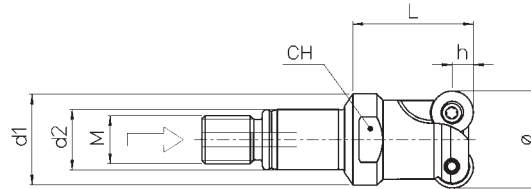
F-MHD' RD

REF.	CODE	Ø	M	d ₁	d ₂	L	h	z	CH			
F-MHD16 RD07-Z2	7516RD07Z220	16	M8	15	10	20	3.5	2	13	RDHX 0702	DG122549	TORX T07
F-MHD20 RD07-Z3	7520RD07Z325	20	M10	19	13	25		3	16			
F-MHD25 RD10-Z3	7525RD10Z332	25	M12	24	16	32	5	3	21	RDHX 1003	DG123507	TORX T15
F-MHD32 RD10-Z4	7532RD10Z440	32	M16	31	20	40		4	27			

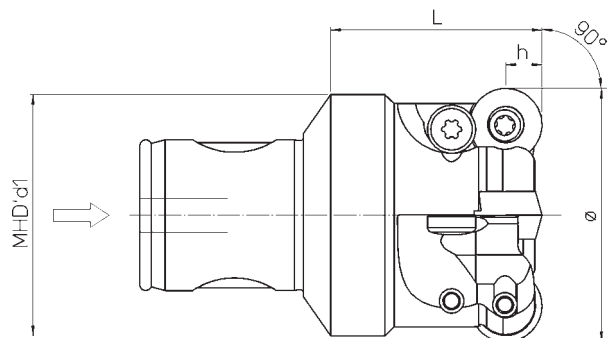
MHD' RD

REF.	CODE	Ø	MHD'd ₁	L	h	z			
MHD'40 RD12-Z4	7540RD12Z435	42	40	35	6	4	RDHX 12T3	DG123509	TORX T15
MHD'50 RD12-Z5	7550RD12Z535	52	50			5			
MHD'63 RD16-Z5	7563RD16Z535	66	63		8	RDHX 1604	DG124510	TORX T20	

p. 61-72

p. 75-78

p. 242-252

p. 222

p. 263

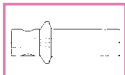
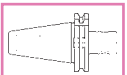

205

MHD' SE

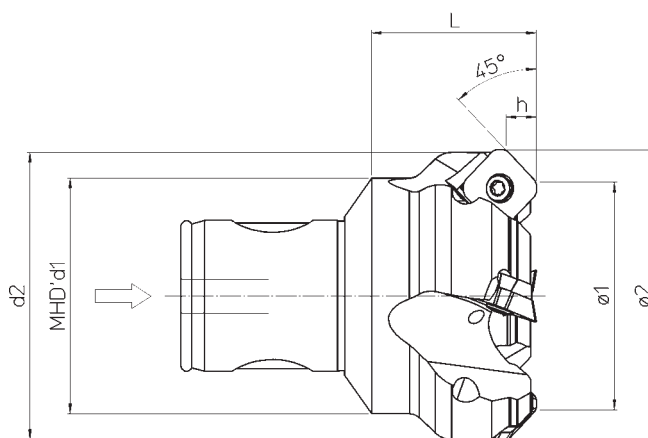

REF.	CODE	Ø ₁	Ø ₂	MHD'd ₁	d ₂	L	h	z			
MHD'40 SE13-Z3	7540SE13Z335	40	53	40	51	35	6	3	SEET 13T3	DG123512P	TORX T15
MHD'50 SE13-Z4	7550SE13Z435	50	63	50	61			4			
MHD'63 SE13-Z5	7563SE13Z535	63	76	63	74			5			

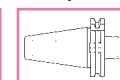
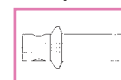

Chamfering milling cutters

Fräser zum fasen

Фрезы для снятия фасок

Frezy do fazowania

Frese per smussare

F-MHD' SP

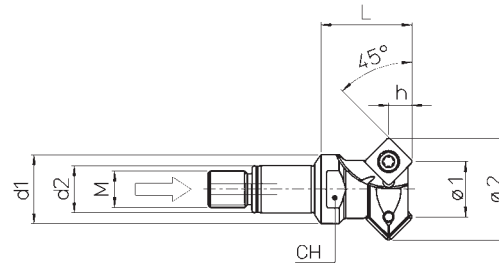

REF.	CODE	Ø ₁	Ø ₂	M	d ₁	d ₂	L	h	z	CH			
F-MHD'20 SP09-Z2	7520SP09Z225	16	28	M10	19	13	25	5.8	2	16	SPEW 09T3	DG123509	TORX T15
F-MHD'25 SP12-Z2	7525SP12Z232	25	41.5	M12	24	16	32	8		21	SPEW 1204	DG124510	TORX T20

Milling cutters
spheric head

Mit kugelkopf

Фрезы со сферической
рабочей частью

Frezy promieniowe

Frese a testa sferica

F-MHD' RA

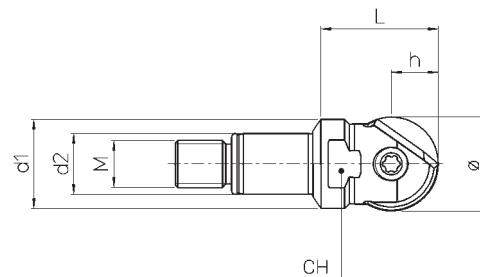

REF.	CODE	Ø ₁	M	d ₁	d ₂	L	h	z	CH			
F-MHD16 RA16-Z1	7516RA16Z120	16	M8	15	10	20	8	2	13	RAD 16.40	DG12RA16	TORX T15
F-MHD20 RA20-Z1	7520RA20Z125	20	M10	19	13	25	10		16	RAD 20.50	DG12RA20	TORX T20
F-MHD25 RA25-Z1	7525RA25Z132	25	M12	24	16	32	12.5		21	RAD 25.60	DG12RA25	TORX T30
F-MHD32 RA32-Z1	7532RA32Z140	32	M16	31	20	40	16		27	RAD 32.70	DG12RA32	TORX T40

p. 61-72

p. 78

p. 223

p. 265

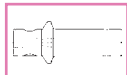
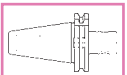

207

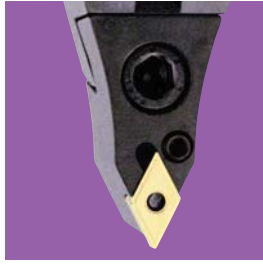

ModulCutD'Andrea

Turning tools

Drehenwerkzeuge

Токарные инструменты
для многоцелевых
обрабатывающих центров

Narzędzia
tokarskie

Utensili di
tornitura

